

ACVT40CS

EV CHARGING POINT MODULAR BOX 3P+N 40A POP+SPD+SCHUKO



Code

030ACVT40CS

EAN

8430892352734

Combiner box technical data

MCB - Circuit breaker	40 A
Curve	C
Breaking capacity EN 60898-1	6 kA
RCCB type	A
Combiner type	AC
Inverter AC output	3P+N
Voltage	415 V AC
Surge protector	Class II
Diferential type	30mA
Incoming current rating	40 A
Surge protector code	-P20
Surge protector type	II
Nominal discharge current (In)	15 kA
Maximum discharge current (Imax)	40 kA
Protection level at In (Up)	2 kV
Ingress protection IP	IP65 - IEC 60529
Impact protection IK	IK08 - IEC 62262
Standards	IEC EN 6143-1/2

Diagrams

Electrical diagram

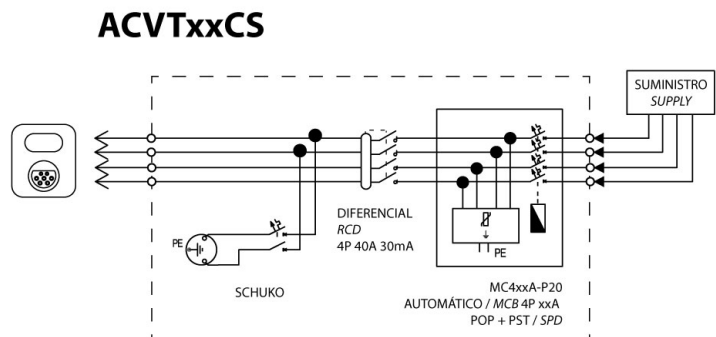

Dimensions

Product height	246 mm
Product width	310 mm
Product length	148 mm

Logistic data

Customs code	85371098
--------------	----------

Connection

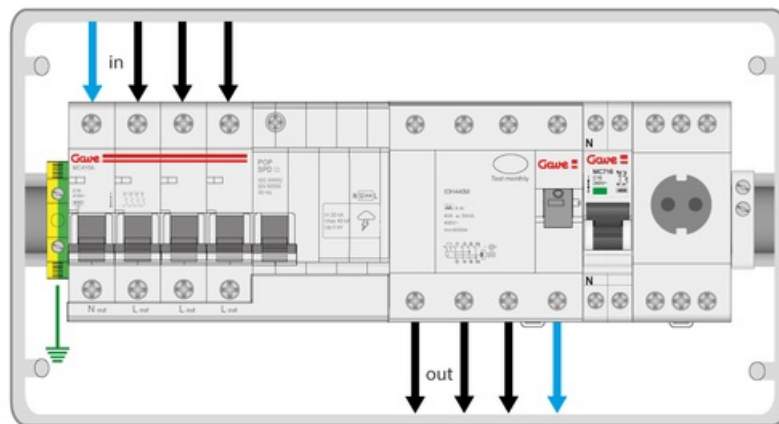

Dimensions

