

PST140-220D

SURGE PROTECTOR DEVICE 220VDC - 40KA TYPE II



Code

002PST140-220D

EAN

8430892312028

Technical data

Standard

IEC 61643-11

Connection

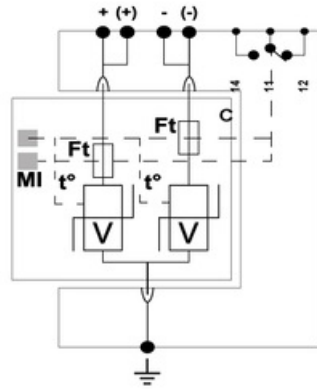

V: Red de varistores
 Mi: Indicador de desconexión
 Ft: Fusible térmico
 t°: Sistema de desconexión térmica
 C: Contacto para remoto

Dimensions

