

ACT25RDA

AC MODULAR COMBINER BOX THREE PHASE MCB 25A RCCB WITH AUTOMATIC RECLOSING TYPE A 30MA



Code	029ACT25RDA
EAN	8430892334334

Product description

Modular combiner box with mcb, rccb and overvoltage protection . Modular circuit breaker 3 poles + neutral 25A C curve breaking capacity 6kA - EN 60898-1. Residual current circuit breaker four pole type A sensitivity 30mA for alternating current with pulsed direct current, protected against nuisance tripping 0,25kA, EN 61008-1 with automatic reclosing according to EN 63024. Overvoltage protection ClassII In 20kA I_{max} 40kA U_p 1,5kV EN 61643-11 with associated fuse protection. Double insulation Class II box in polycarbonate material for indoor and outdoor use with high impact resistance (IK08). Dimensions de 286x418x148mm

Combiner box technical data

MCB - Circuit breaker	25 A
Curve	C
Breaking capacity EN 60898-1	6 kA
RCCB type	A - 30mA (EN 61008-1 / EN 63024)
Inverter AC output	3P+N
Surge protector	Class II
Differential type	30mA
Surge protector code	PSTC440
Surge protector type	II
Nominal discharge current (In)	20 kA
Maximum discharge current (Imax)	40 kA
Protection level at In (Up)	1.5 kV
Ingress protection IP	IP65 - IEC 60529
Impact protection IK	IK08 - IEC 62262

Diagrams

Electrical diagram

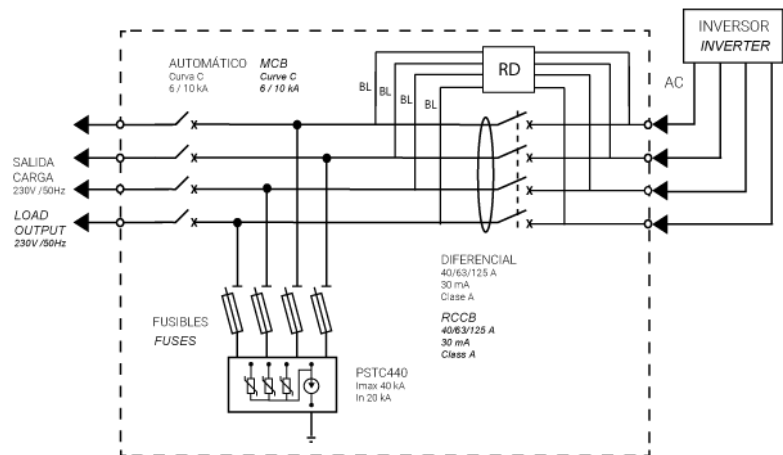

Dimensions

Product height	286 mm
Product width	418 mm
Product length	148 mm

Logistic data

Customs code	85371098
--------------	----------

Connection

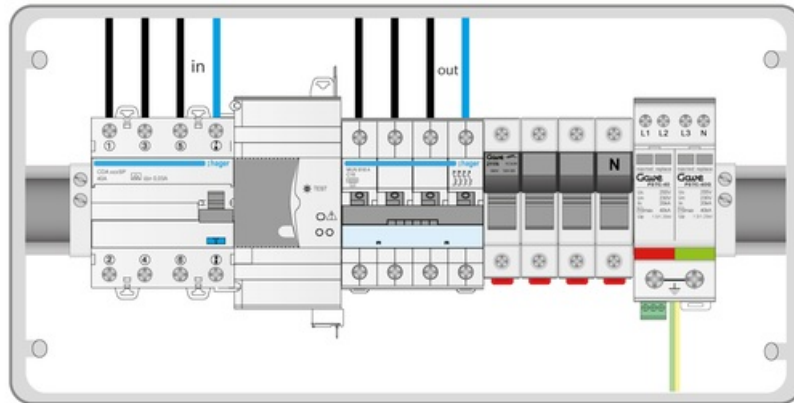

Dimensions

