

ACM40H

AC COMBINER BOX FOR HIBRID INVERTER SINGLE PHASE 40A MCBs



Code	029ACM40H
EAN	8430892332361

Product description

Modular combiner box for hybrid inverter with grid circuit and backup circuit. Each circuit is equipped with mcb and rccb protection. Modular circuit breakers two pole 40A C curve breaking capacity 6kA - EN 60898-1. Residual current circuit breakers two pole type A sensitivity 30mA for alternating current with pulsed direct current, protected against nuisance tripping 0,25kA, EN 61008-1. Overvoltage protection ClassII In 20kA I_{max} 40kA U_p 1,5kV EN 61643-11 with associated fuse protection. Double insulation Class II box in polycarbonate material for indoor and outdoor use with high impact resistance (IK08). Available space to add-on energy meter. Dimensions 286x418x148

Combiner box technical data

MCB - Circuit breaker	40 A
Curve	C
Breaking capacity EN 60898-1	6 kA
RCCB type	A - 30mA
MCB backup circuit	20A - C - 6kA
RCCD backup circuit	A 30mA
Inverter AC output	1P+N
Diferential type	30mA
Surge protector code	PSTC40
Surge protector type	II
Ingress protection IP	IP65 - IEC 60529
Impact protection IK	IK08 - IEC 62262

Diagrams

Electrical diagram

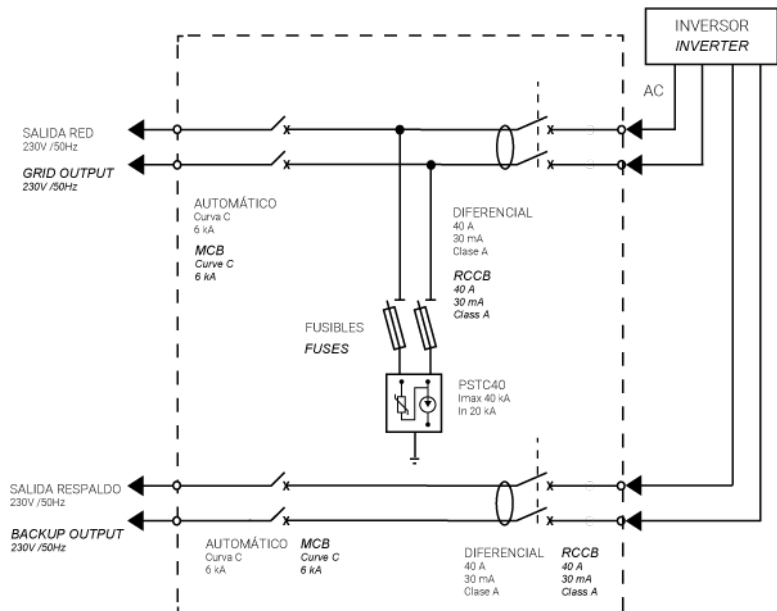

Dimensions

Product height	290 mm
Product width	420 mm
Product length	160 mm
Product weight (kg)	3.28

Logistic data

Customs code	85371098
--------------	----------

Connection

